**ULTRA FAST NiCd BATTERY CHARGING
USING ST6210 MICROCONTROLLER**

L. Wuidart, P. Richter

INTRODUCTION

Today many cordless and portable equipments are supplied by a Nickel-Cadmium (NiCd) battery. The ultra fast charging of these batteries in less than half an hour is a very attractive service for users. Such a short charging time requires an "Ultra Fast" battery, a supply with a relatively high output power, and a charge control circuit more complex than for standard chargers. Moreover, automatic battery voltage identification is an appreciable feature.

The power converter proposed in this note is able to fully charge a common NiCd battery pack of 1.2Ah/7.2V within 15 minutes. The power converter has thus a corresponding output power capability of roughly 80W. The converter operates as a current source providing a constant 7A current to the battery while charging.

The battery charge is controlled by an economical microcontroller, the ST6210, a member of the ST6 microcontroller family. The programmed control provided by the ST6210 allows the charging of NiCd battery packs from 2 to 6 cells (2.4V to 7.2V). The supply to the microcontroller is simply generated from an auxiliary winding of the power transformer.

THE POWER CONVERTER

The asymmetrical half-bridge is today considered as one of the most attractive topologies for the primary side of a 220Vac off-line Switch Mode Power Supply (SMPS, see Figure 1). Adding the SGS-THOMSON AVS10 kit allows the automatic sensing and adaptation to input voltages in the range of 90 to 240Vac.

Contrary to single switch structures, the leakage inductance of the power transformer is much less critical. The two demagnetization diodes (BYT01/400) provide a simple non-dissipative way to systematically clamp the voltage across the switches to the input DC voltage V_{in} . This allows the use of standard 500V power MOSFET devices, such as the IRF830FI (in isolated ISOWATT 220 package), simply driven by a small pulse transformer.

Figure 1. Ultra Fast NiCd battery charger schematic (80W AC/DC)

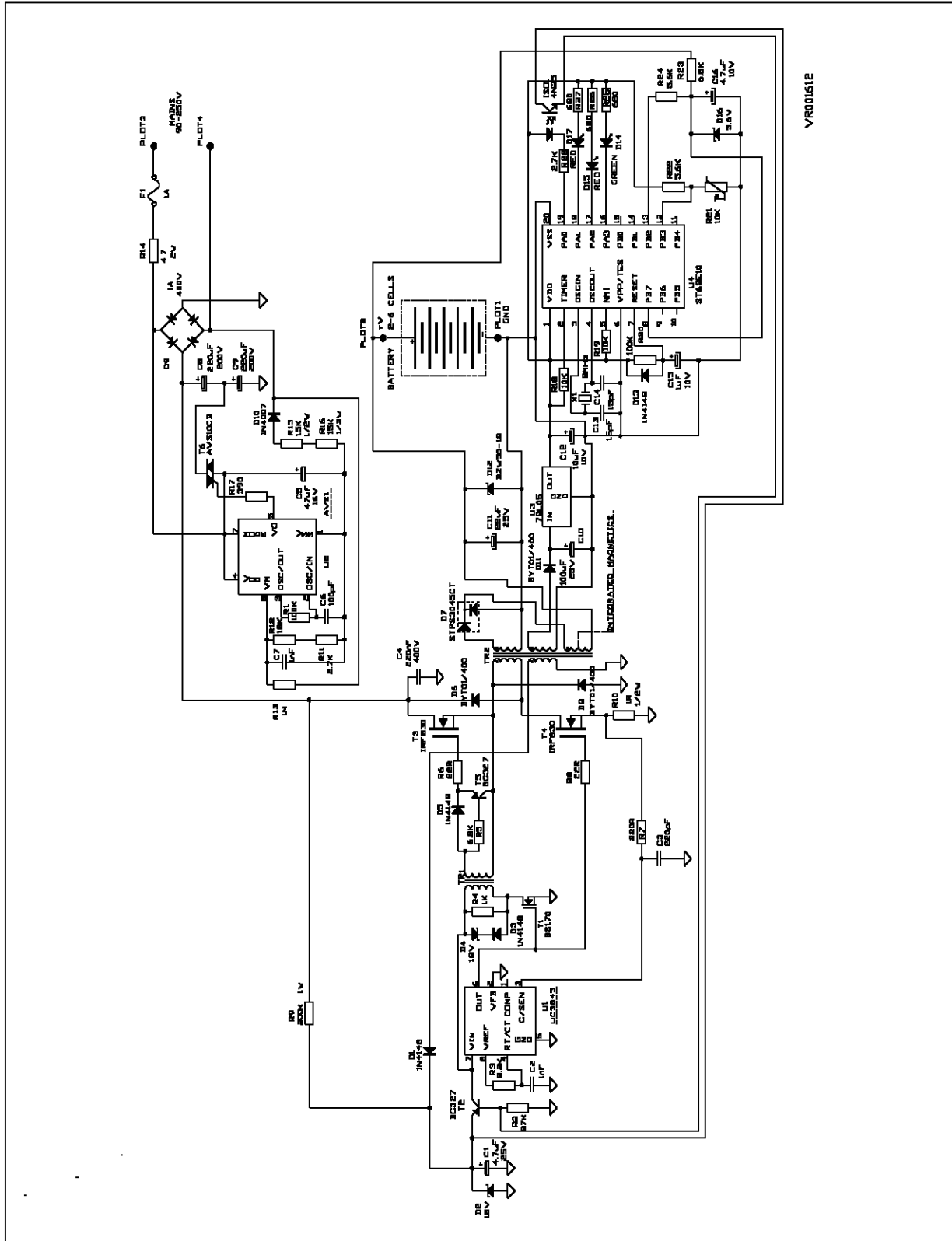

VR0001612

The power converter is totally controlled from the primary side with a standard Pulse Width Modulation (PWM) control IC, the UC3845 regulating in current mode. A single optocoupler makes this SMPS operate as a battery charger. The SMPS is turned on or off from the secondary by the ST6210 microcontroller via this optocoupler.

The switching frequency is fixed at 100kHz in order to keep the magnetic part to a reasonable manufacturing cost level. The power transformer and the output inductor can be integrated on a single ferrite core [4]. This integrated magnetic technique can be optimised to allow a significant shrinking of the power converter size.

For more information on the power converter, refer to reference [4] of the bibliography.

BATTERY CHARGE CONTROL

Ultra Fast Charge Control Method

For Ultra fast charge systems - under half an hour - the majority of battery manufacturers recommend the negative delta voltage method ($-\Delta V$) otherwise called the negative slope cut-off circuit [2] [3].

Figure 2. One NiCd Cell Charge Characteristic

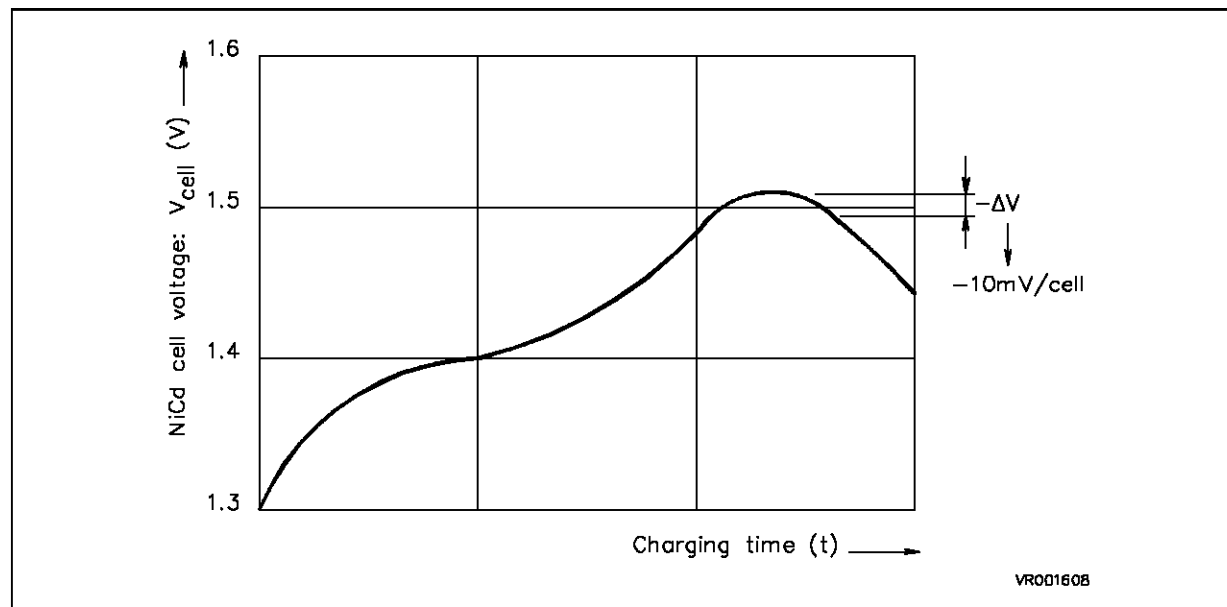

When a NiCd battery reaches full charge, its voltage decreases slightly (Figure 2). The negative delta voltage method ($-\Delta V$) consists of stopping the charge as soon as the voltage characteristic slope becomes negative. This technique allows the very rapid charge of a NiCd battery, near to its full capacity. Moreover, no compensation for the age of the battery is required because only relative voltages are measured.

In this application, the battery voltage is sensed by a ST6210 microcontroller housed in 20 pin dual in line package. The integrated Analog to Digital converter (ADC) of this micro-controller is able to detect a typical voltage drop of $-10mV/cell$.

MONITORING FUNCTIONS

The battery charge is totally monitored by the HCMOS ST6210 in PDIP or PSO 20 pin package, the ST6210. By using this micro-controller, additional monitoring functions can be easily added to the Ultra fast charge control program.

Stand-by current charge: Burst mode

Once the negative voltage drop has been detected by the ST6210, the ultra-fast charging is stopped and the power converter supplies the battery with a stand-by current around 120mA. This stand-by charge is provided by burst mode current control. The converter is successively turned on and off at 25Hz with a small duty cycle of 0.016. The ST6210 manages this burst mode from the secondary side via an optocoupler to the auxiliary supply of the PWM control IC (UC3845).

A small 100 μ F reservoir capacitor is sufficient to keep the ST6210 correctly supplied during the off periods (40ms) of the burst mode. This is possible due to the low current consumption in run mode of the ST6210 HCMOS micro-controller (typically 3mA with an 8MHz oscillator, reducing to typically 1mA for a 2MHz oscillator).

Battery temperature protection

Temperature protection is simply realized by using an NTC resistor placed on the battery pack. This NTC resistor is directly connected to another input of the ADC of the ST6210. When the battery temperature reaches 40°C during an Ultra Fast charge phase, the converter is switched into burst mode to protect the battery.

Battery presence

The ST6210 program detects whether the battery pack is connected or not. When the battery is not connected, the converter is turned into burst mode. The resulting stand-by current (120mA) flows into the output Transil diode (BZW 50-12).

CHARGE CONTROL PROGRAM DESCRIPTION

Figure 3 shows the main flow chart of the program for the complete charge control. The overall system is reset after each new mains connection.

Battery voltage measurement:

The battery voltage is directly measured by the ST6210 Analog to Digital Converter through a resistor divider chain. The technique used allows the ST6210 to automatically adapt to the battery type and voltage (from 2 to 6 cells, 2.4V to 7.2V).

Figure 3. Main flow chart of the Ultra Fast Charge control program

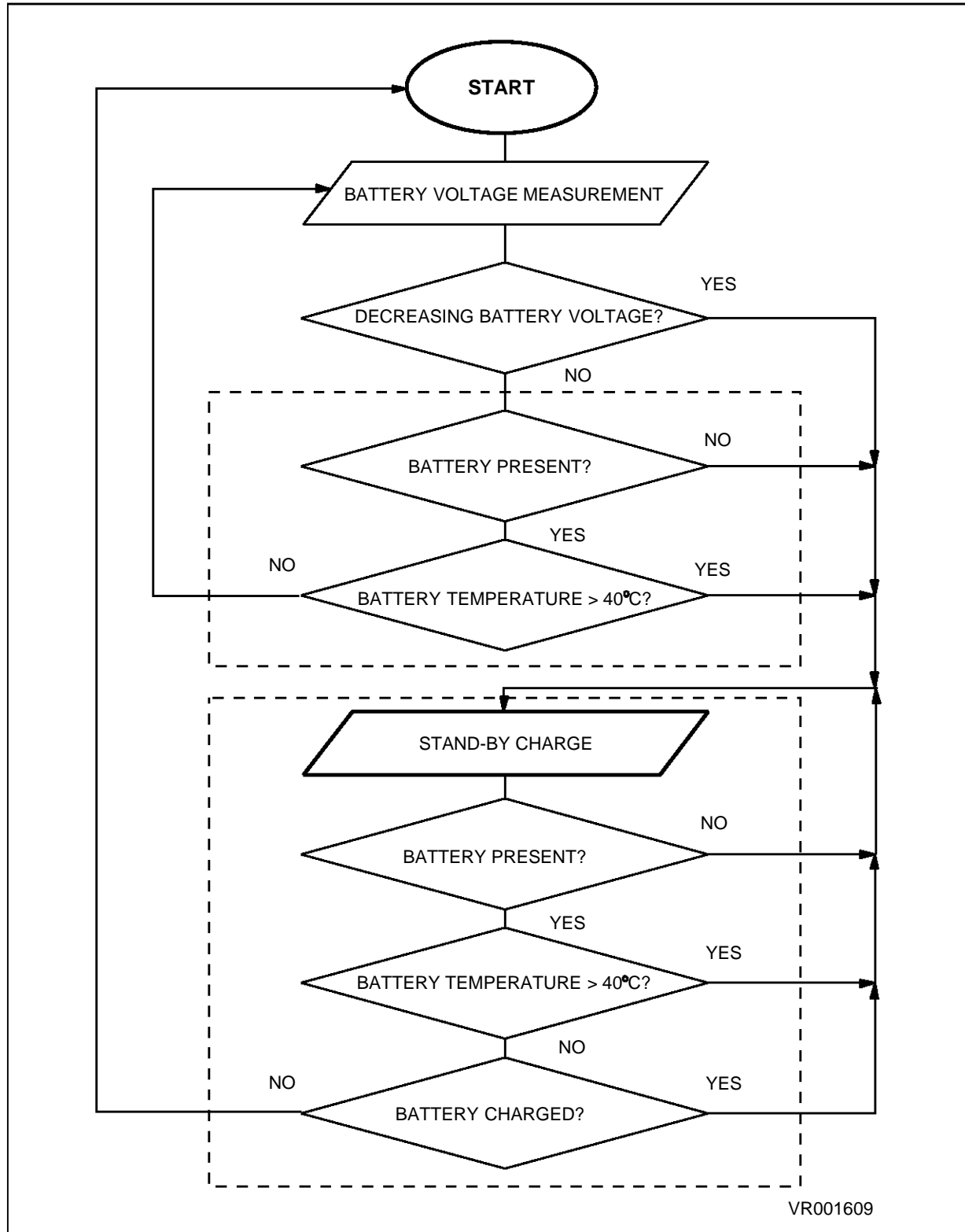

Monitoring principle

The ST6210 averages a series of 256 battery voltage measurements ($\sum M_n$). The 256 conversions are made in a time frame of around 19 ms, with an inter-frame delay time of 1s (in this example). An average AV_r of the last 8 averaged values is made according to the formula:

$$AV_r = \sum \frac{\sum M_n \dots \sum M_{n-8}}{8}$$

This AV_r value is compared to the previous average AV_{r-1} and the highest value is stored. This rolling average value follows the battery voltage curve. Once the AV_r value begins to decrease, indicating the battery is fully charged, the ST6210 stops the Ultra Fast charging.

Figure 4. Sequencing principle of the Battery Voltage measurement.

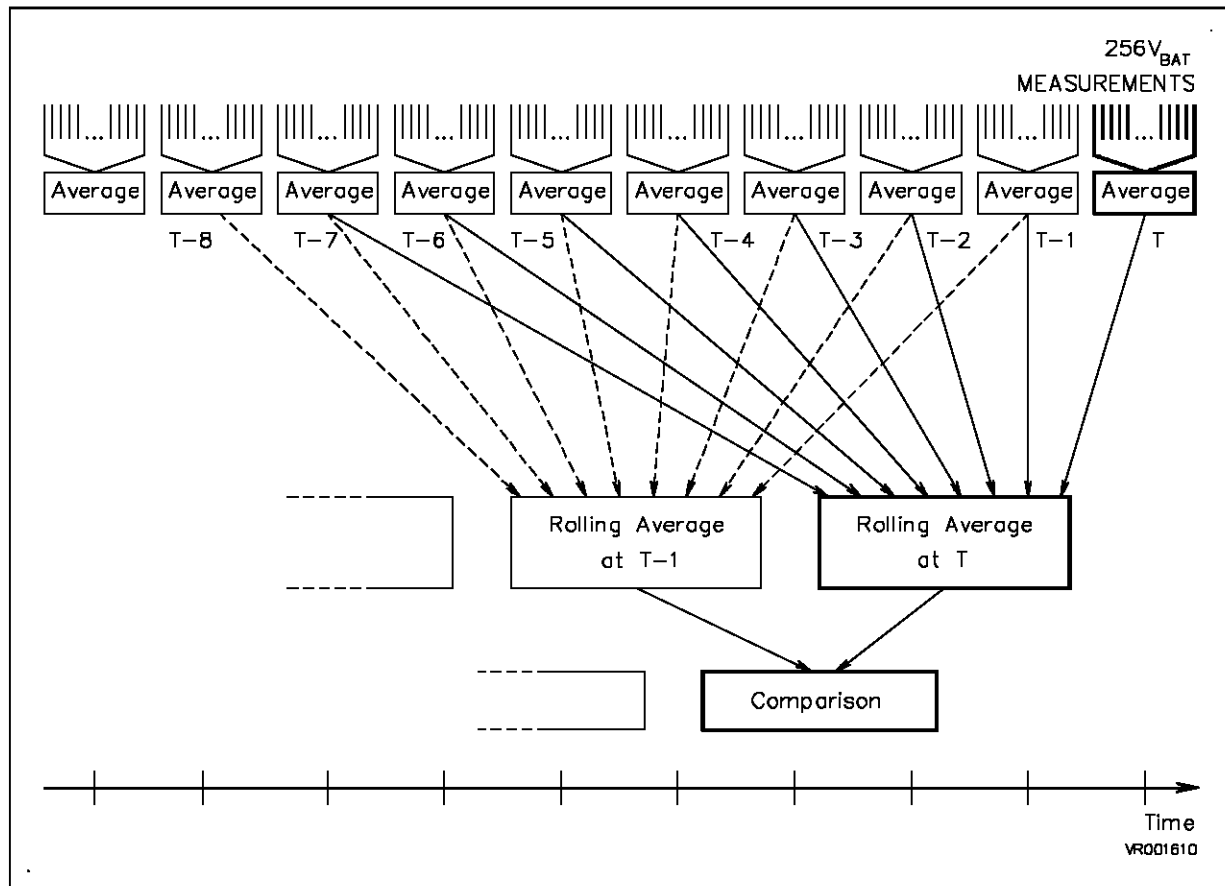

The response time to detect the battery voltage drop ranges from 1 to 8 seconds, depending on the slope of the battery voltage curve at the charge completion. A longer delay time is able to increase the noise immunity, but at the cost of an extended response time.

Figure 5. VBAT and Pack.Temp Vs time

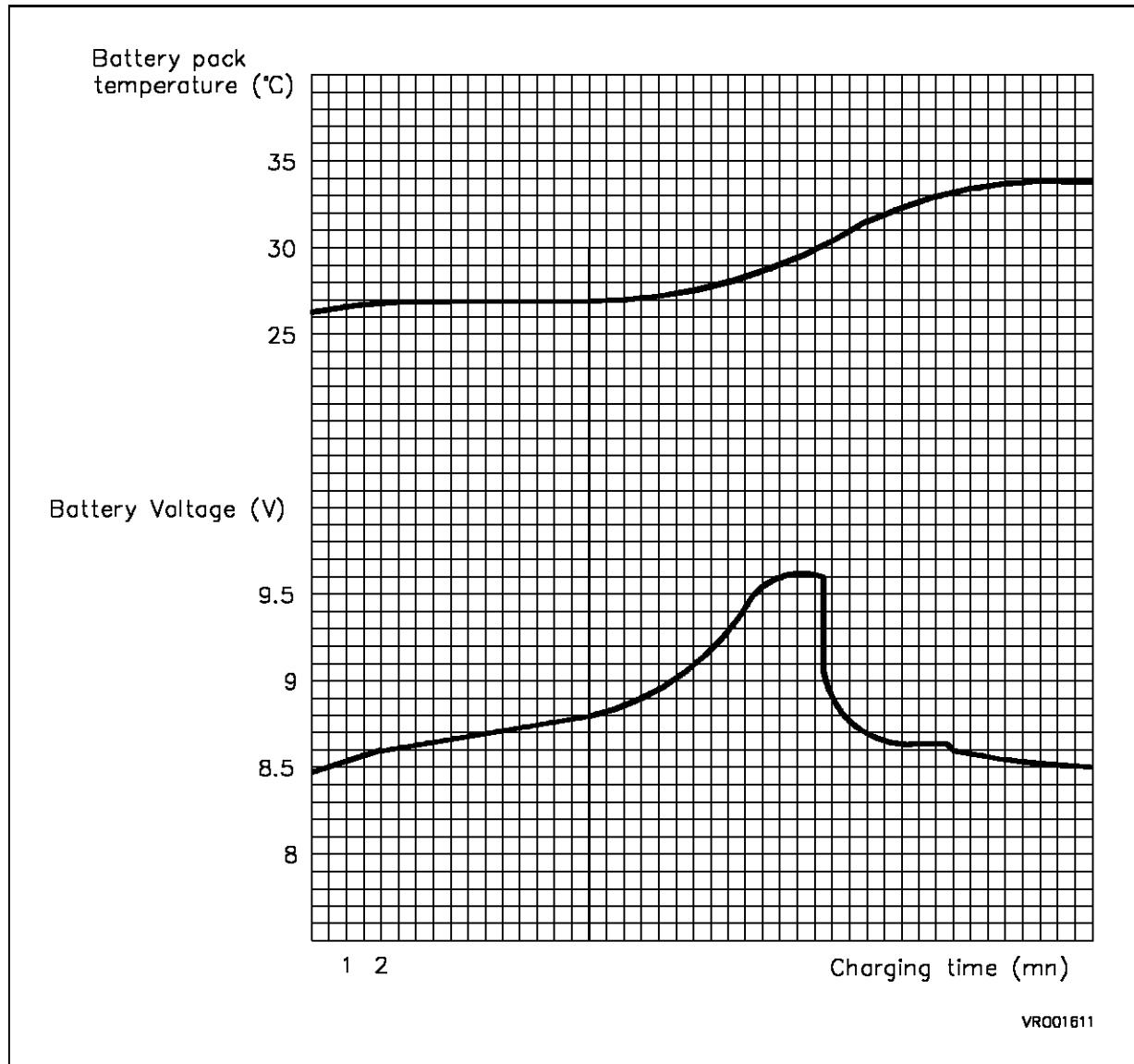

PRACTICAL RESULTS

Tests made with different battery packs confirm that the battery charge is efficiently controlled by the ST6210 using its internal A/D converter. Results on the battery voltage and temperature pack versus charging time are shown below.

These recordings have been made with a common 1.2Ah/7.2V NiCd battery pack for cordless drills. The temperature of the battery pack does not exceed 33°C for an ambient temperature of 26°C.

SUMMARY

Charging a NiCd battery in less than half an hour saves battery packs and time. It can enlarge the use of battery powered equipments, especially in professional applications.

Such ultra fast charging has to be carefully monitored to maximize the life time of the battery and the charge safety. Moreover, this improvement needs to be achieved with a compact equipment including a minimum of components.

The proposed power charger is realized with a conventional SMPS topology. The size and number of the magnetic components are minimized by using an integrated magnetic technique.

This note shows that an ultra fast charge can be totally monitored by a single 20 pin HCMOS micro-controller, the ST6210.

The program used in the validation of this Battery Charger is available from SGS-THOMSON. This software routine has the basic ultra fast charger and many additional features including stand-by charge, temperature protection, battery presence detection and automatic battery voltage sensing. Given the flexibility offered by the programmability of the ST6210, other specific requirements can be implemented. Consult your local SGS-THOMSON sales office or franchised distributor.

REFERENCES

- [1] G.E. BLOOM, "CORE SELECTION FOR INTEGRATED-MAGNETIC POWER CONVERTERS", Powertechnics Magazine - June 1990.
- [2] A. WATSON-SWAGER, "FAST-CHARGE BATTERIES", EDN, Dec. 7, 1989.
- [3] M. GROSSMAN, "FOCUS ON RE-CHARGEABLE BATTERIES: ECONOMIC PORTABLE POWER", Electronic Design, March 3, 1988.
- [4] L. WUIDART, "ULTRA FAST NiCd BATTERY CHARGER WITH INTEGRATED MAGNETIC", PCIM - June 1991 - Nürnberg/G

ANNEX

The application presented in this note is basically an 80W off-line AC/DC power supply with a battery monitoring block. It can be easily extended to other power ranges or DC/DC applications, keeping the battery monitoring block identical.

This annex presents the schematic of two different versions (35W AC/DC and 15W DC/DC). The table below summarizes the major characteristics of these applications:

Output Power (W)	Charge Current (A)	Battery Pack	Charging Time (mn)	Input Voltage (V)	Typical Applications
80	7	7.2V - 1.2Ah 2 to 6 cells	15	90 - 250 (AC)	Power tool
35	3.5	7.2V - 1.2Ah 2 to 6 cells	30	190 - 245 (AC)	Mobile Phone Note Book Camcorder
15	1.2	4.8V - 0.6Ah 2 to 4 cells	30	12 (DC)	Mobile Phone Toys

Figure 6. 35W AC/DC Battery Charger Schematic

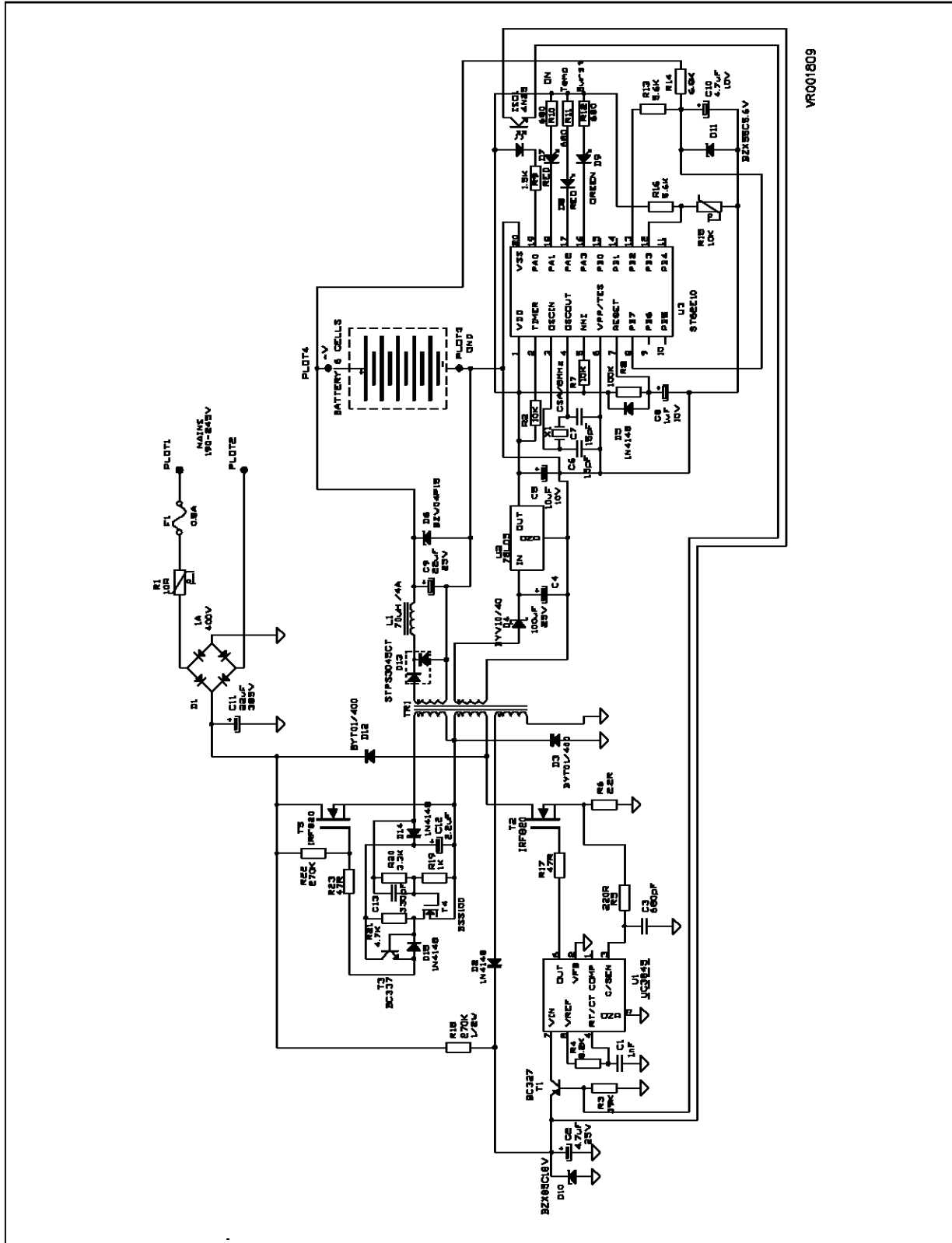
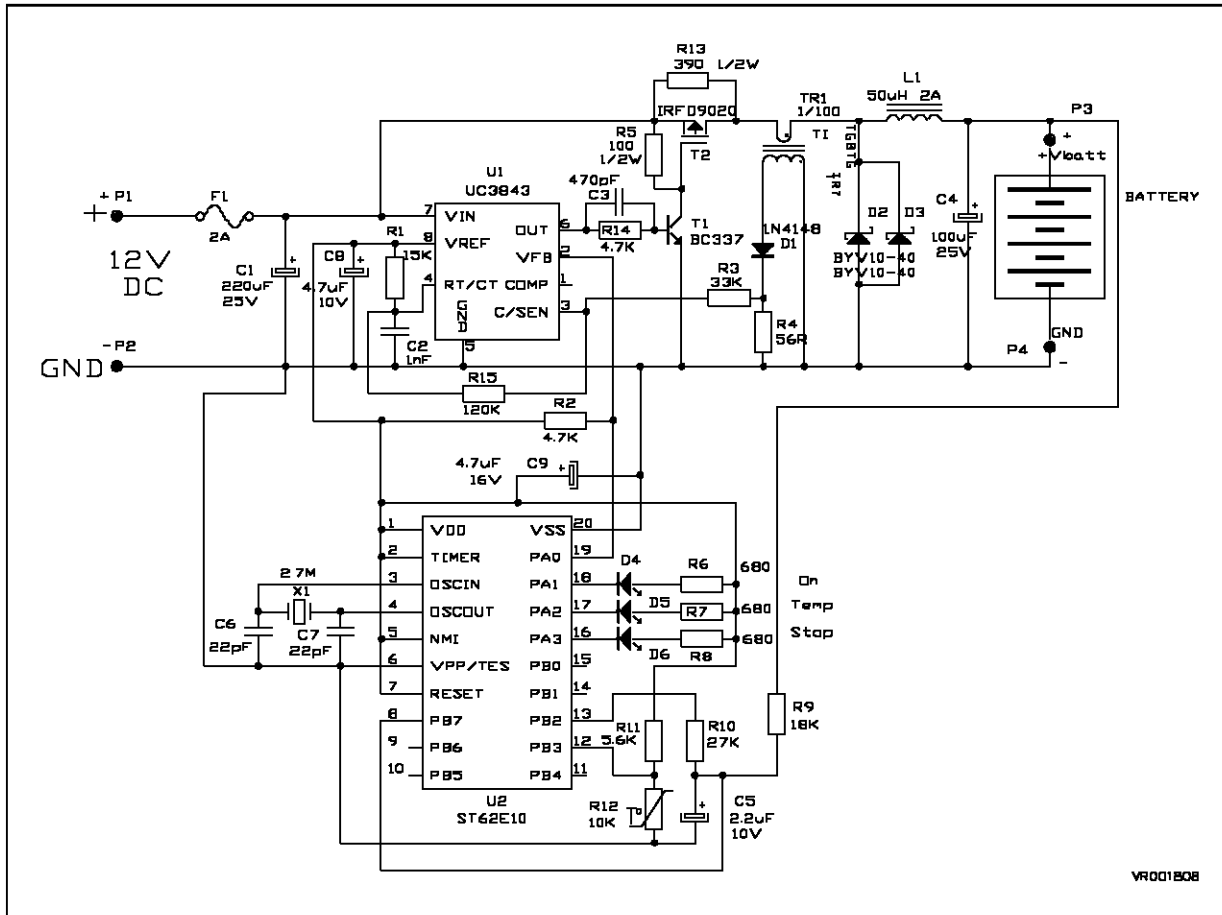

Figure 7. 15W DC/DC Battery Charger Schematic



NOTES:

Information furnished is believed to be accurate and reliable. However, SGS-THOMSON Microelectronics assumes no responsibility for the consequences of use of such information nor for any infringement of patents or other rights of third parties which may result from its use. No license is granted by implication or otherwise under any patent or patent rights of SGS-THOMSON Microelectronics. Specifications mentioned in this publication are subject to change without notice.

This publication supersedes and replaces all information previously supplied.

SGS-THOMSON Microelectronics products are not authorized for use as critical components in life support devices or systems without the express written approval of SGS-THOMSON Microelectronics.

© 1994 SGS-THOMSON Microelectronics - All rights reserved.

Purchase of I²C Components by SGS-THOMSON Microelectronics conveys a license under the Philips I²C Patent. Rights to use these components in an I²C system is granted provided that the system conforms to the I²C Standard Specification as defined by Philips.

SGS-THOMSON Microelectronics Group of Companies

Australia - Brazil - France - Germany - Hong Kong - Italy - Japan - Korea - Malaysia - Malta - Morocco - The Netherlands
Singapore - Spain - Sweden - Switzerland - Taiwan - Thailand - United Kingdom - U.S.A.